

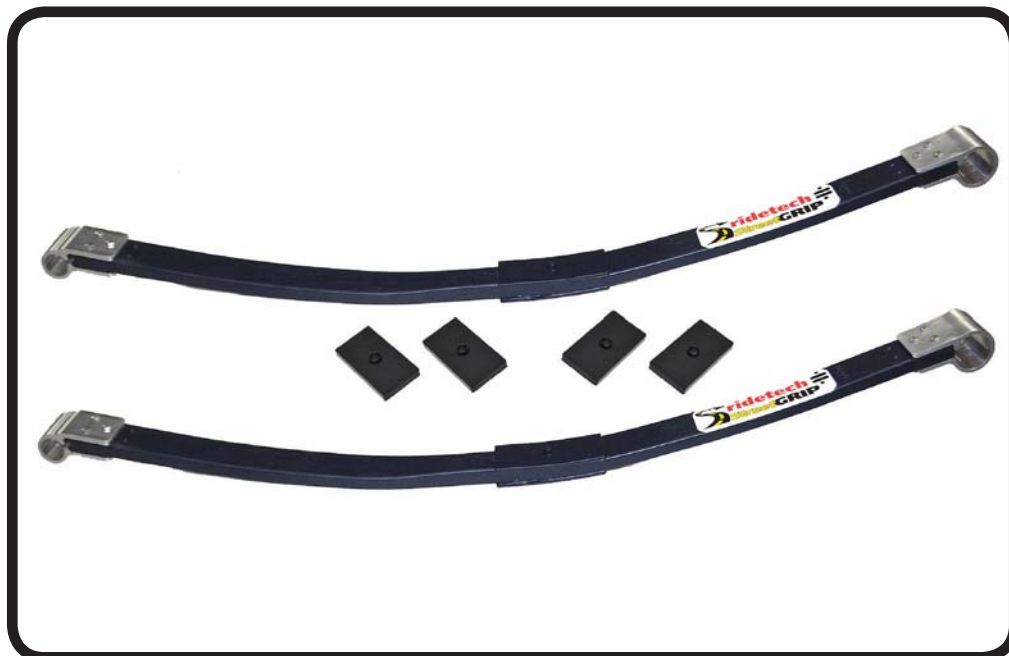

### Part # 11174799 - 1970-1981 F-Body Composite Leaf Springs

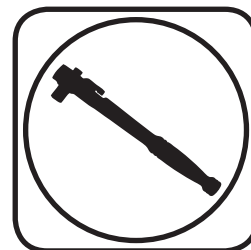

#### Recommended Tools

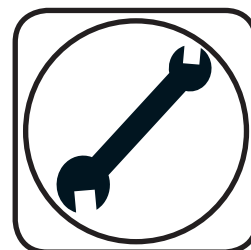

## 1970-1981 F-Body Composite Leaf Springs Installation Instructions

#### Table of contents

- Page 2..... Included components and Hardware List
- Page 3..... Leaf Spring Installation
- Page 4..... Leaf Spring Installation

THESE LEAF SPRINGS WILL ACCEPT OEM LEAF SPRING BUSHINGS. THE RIDETECH DELRIN LEAF SPRING BUSHING KIT (11175399) IS RECOMMENDED TO ACHIEVE MAXIMUM PERFORMANCE.





### Major Components .....In the box

Part #	Description	QTY
90002550	Leaf Spring Blade Assembly	2
90002498	Upper Leaf Spring Clamping Plates	2
90002499	Lower Leaf Spring Clamping Plate	2
99371050	3/8"-16 x 1 1/2" Conical Bolt	6
99372009	3/8"-16 U-Nut	6

### Getting Started.....

**IF INSTALLING DELRIN LEAF SPRING BUSHINGS, THEY SHOULD BE INSTALLED IN CONJUNCTION WITH THE LEAF SPRINGS.**

**IT IS VERY IMPORTANT THAT NOTHING COMES IN CONTACT WITH THE LEAF SPRING.**

The Ridetech Composite Leaf Springs are setup to use the Ridetech Delrin Bushing Kit (11175399) or OEM style bushings. They are also designed to fit into the OEM front leaf spring mount.

1. Jack the car up and support it by the frame rails. You will need to raise and lower the rear differential with a jack to ease installation. With the car supported by the frame, put the jack underneath the rear end housing and raise the jack up just enough to support the differential. Disconnect the bottom of the shock and remove the rear leaf springs. Retain the OEM hardware.
2. If you purchased the Leaf Springs only, you will need to install bushings into Leaf Spring eyes. If a complete StreetGrip kit was purchased, Delrin Bushings will be preinstalled.
3. If using the Ridetech Delrin Bushings, the rear Frame Bushings will need to be installed before the Leaf Spring can be installed. Refer to the Delrin Bushing instructions for the correct procedure.

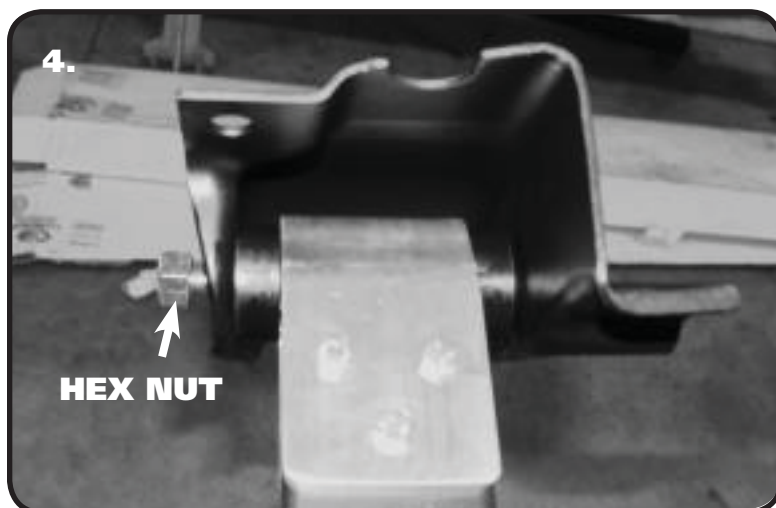

4. Bolt the **LARGE BUSHING END** of the Composite Leaf Spring into the OEM front leaf spring mount using a 1/2"-13 x 5" Hex Bolt and 1/2"-13 Nylok Nut. The Bolt must be installed with the threads pointing to the **OUT-SIDE** of the car. Diagram #4 is the correct.

**NOTE: Front spring pocket must be removed from car before installing new springs. New Hardware is supplied in kit.**



### Leaf Spring Installation

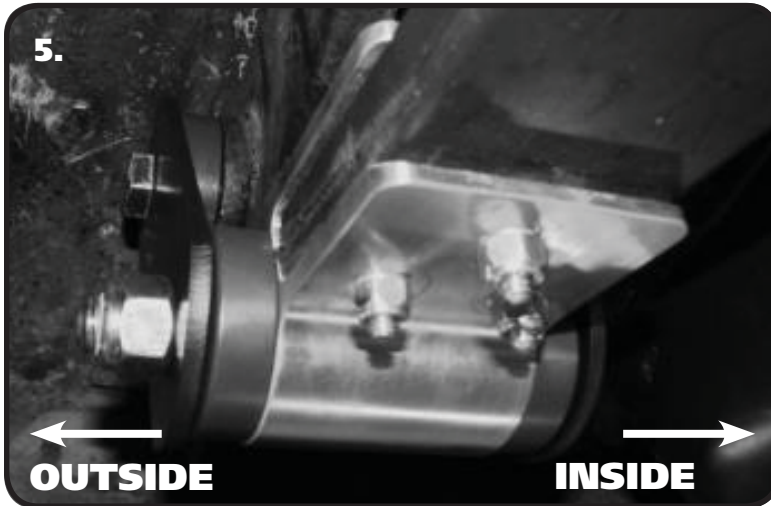

5. Attach the rear of the Composite Leaf Spring to the rear mount. If you are using the Ridetech Delrin Bushings, new Shackles and Hardware is supplied with them. Attach a Shackle Plate to each side of the Frame Bushing using a 1/2"-13 x 5" Bolt (WITH THREADS POINTING TO INSIDE OF CAR) and 1/2"-13 Nylok Nut. Do not tighten. Align the remaining bolt holes in the shackle plates with the sleeve in the rear Leaf Spring bushing. Install a 1/2"-13 x 5" Bolt (WITH THREADS POINTING TO OUTSIDE OF CAR) and 1/2"-13 Nylok Nut. Do Not tighten hardware, it will get tightened later.

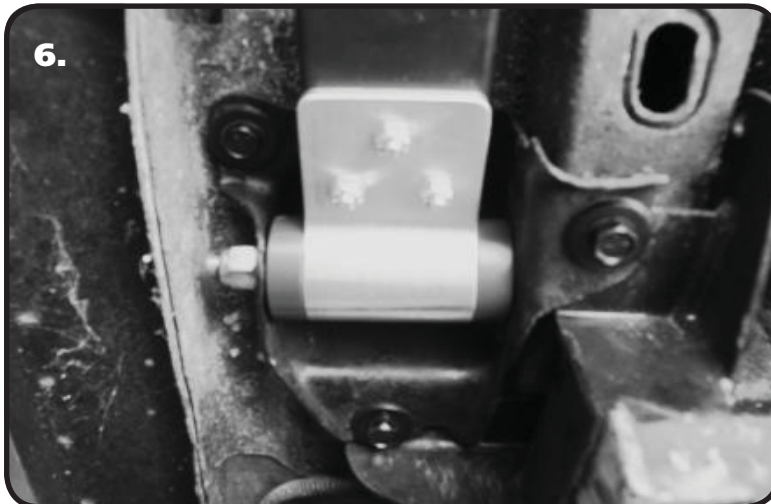

6. Swing the Leaf Spring up and attached the front mount to the car using the supplied 3/8"-16 x 1 1/2" Conical Body Bolts and U-Nuts. Tighten Hardware

**Note:** You may have to jack the rear differential up enough to swing the leaf spring in place.

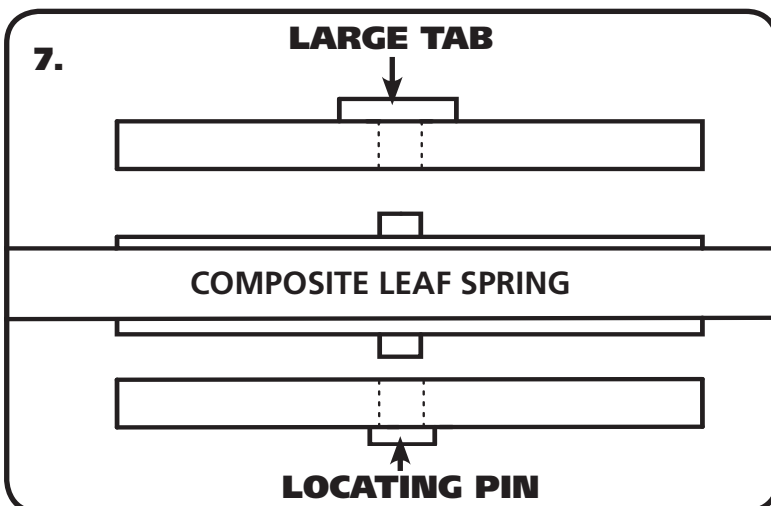

7. The Composite Leaf Spring has to be clamped in place with the OEM lower plate. A new Lower Plate is supplied, if you are also installing Ridetech Shocks. The composite leaf spring requires a Clamping Plate on the top and bottom of the leaf spring. The TOP clamping plate has a LARGE TAB attached to the top of it. The BOTTOM clamping plate has a LOCATING PIN on the bottom of it. **The top and bottom leaf spring locating pins need to be inserted into the holes in the Clamping Plates on the FLAT SIDE.** The tab on the top clamping plate will nest in the leaf spring mount. The bottom clamping plate pin will need to be inserted into the hole in the lower plate to correctly position the rear differential.



### Leaf Spring Installation

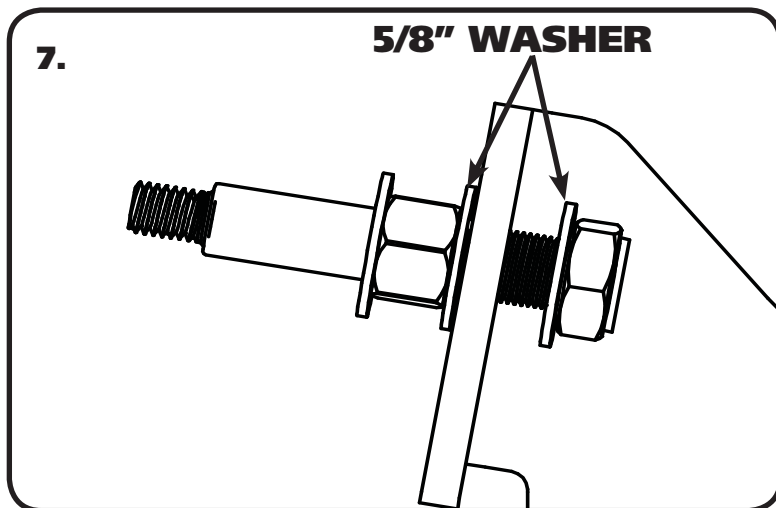

7. If you are installing the Ridetech Shock Kit, we recommend installing the Shock Studs in the Leaf Spring Clamping Plate before installing the plates in the car. The Shock Studs are supplied in the shock kit. Refer to **Images 7&8** for proper installation. The shock stud hardware is packaged with the stud. Install a 5/8" washer onto the 5/8" threads. Insert the stud into the hole on the plate. Install a washer on the threads, followed by a 5/8"-18 Locknut. Tighten 5/8" Nut.



8. Lower the differential onto the Leaf Spring with the top Clamping Plate in place like shown in Diagram "7". The TAB on the Top Clamping Plate will nest in the OEM leaf spring mount. Install the lower Clamping Plate followed by the OEM lower mount **being sure the Pins and Holes are aligned**. Install the OEM hardware.

Evenly tighten the hardware in a crisscross fashion. Torque the nuts to 55 ftlbs.

**Note: When tightening the mounts, pay attention to the pads on the springs to make sure there is visible compression of the pads. .030"- .060" of compression is needed for the springs to be securely mounted. All of the clamping force needs to be on the spring itself.**

9. Tighten the Bushing hardware, torquing it to 75 ftlbs. The Delrin Bushings will not bind, so it isn't necessary to have the car at ride height. If using OEM style rubber bushings, the car will need to be on the ground at ride height before tighten the bushing hardware.

10. Install the Ridetech HQ Series shocks. Refer to the shock instructions.

**DOUBLE CHECK TO MAKE SURE NOTHING IS COMING INTO CONTACT WITH THE LEAF SPRING.**