

### 2011 FORD MUSTANG 3.7L

**Warning:** When working on, under, or around any vehicle exercise caution. Please allow the vehicle's exhaust system to cool before removal, as exhaust system temperatures may cause severe burns. If working without a lift, always consult vehicle manual for correct lifting specifications. Always wear safety glasses and ensure a safe work area. Serious injury or death could occur if safety measures are not followed.

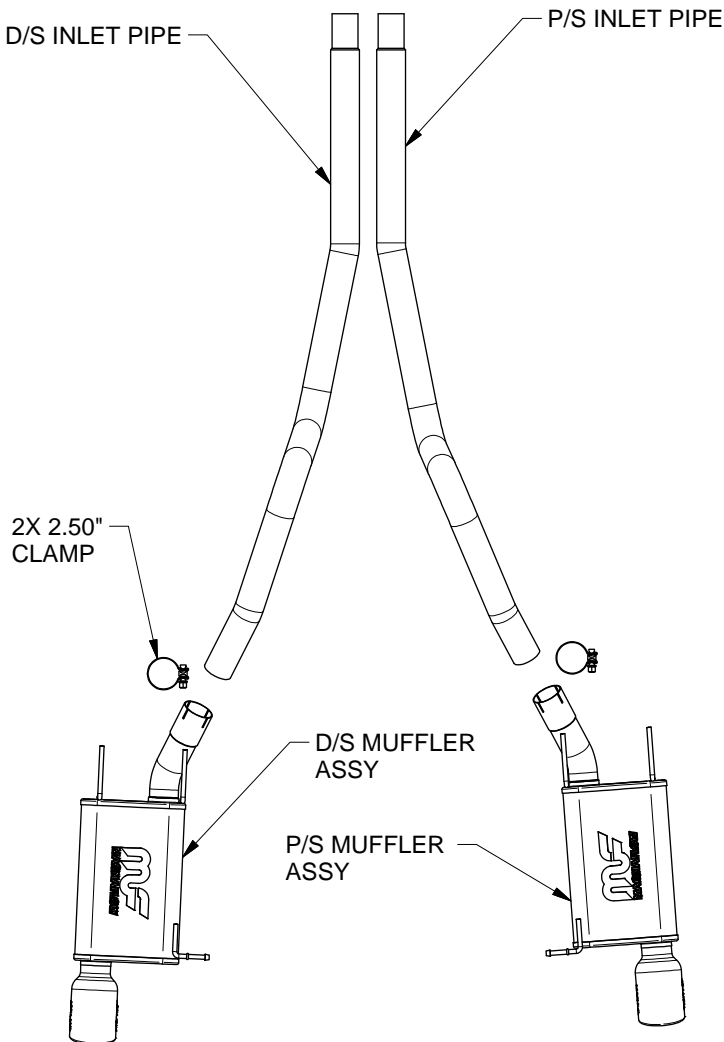

**Step 1:** (Carefully read all instructions before installation) To remove the OEM exhaust system, unbolt the clamps fastening the muffler inlets to the over-axle pipes. Unbolt the muffler hanger brackets from the frame, and remove the mufflers from the vehicle (The brackets will be reused). Remove the over-axle pipes in a similar fashion. Do not discard the OEM band clamps or damage the OEM rubber insulators, as they will be used to mount the new system.

**Step 2:** Remove the OEM hanger brackets from the mufflers and reattach them to the frame of the vehicle. (Make note of the hanger isolator orientation as improper installation will cause fitment issues). Leave all the clamps and fasteners loose for the final adjustment of the complete system. Install the new Muffler Assemblies by fitting the welded hangers into the rubber insulators in the brackets. Fit the new Inlet Pipes into place and fasten them to the catalytic converters and new Muffler Assemblies using the OEM clamps at the converters and the new supplied band clamps at the mufflers.

**Step 3:** With all components mounted loosely, adjust the system for overall aesthetics and clearance of frame & bodywork. (MAGNAFLOW recommends at least 1/2" of clearance between the exhaust system and any body panels to prevent heat-related body damage or fire.)

**Step 4:** Once a final position has been chosen for the new system, evenly tighten all fasteners from front to rear. The supplied band clamps must be VERY tight to properly align the pipes and prevent leaks (Approximately 40ft-lbs). Inspect all fasteners after 25-50 miles of operation and retighten if necessary.

**\*\* Magnaflow Performance Exhaust recommends professional installation on all their products**