

Made in America

Lifetime Guarantee

Thank you for purchasing this instrument from Intellitronix. We value our customers!

INSTALLATION GUIDE

Oldsmobile Cutlass Digital Dash Panel

Part Number: DP1407

Year Series: 1978 – 1988



*** Always disconnect the battery *before* attempting any electrical work on your vehicle.***

KIT COMPONENTS

One (1) Digital Circuit Board with Speedometer, Tachometer, fuel, temperature, voltmeter, oil pressure gauges and clock.

One (1) Smoked Acrylic Lens *** Peel off protective covering from both sides of the lens ***

One (1) ABS Black Plastic Overlay

One (1) Temperature Sending Unit (**S8013**) 1/8" NPT, 0-255 Deg., 1/2" NPT Bushing

One (1) Pressure Sending Unit (**S8434**) 1/8" NPT, 0-100 PSI Oil Pressure

One (1) Universal Speedometer Sensor (**S9013**) 7/8" NPT Industry Standard threads

One (1) Mounting Kit: 4 - Phillips head #6 - 20 x 1-inch black oxide screws; 8 ¼" plastic spacers

DASH PANEL INSTALLATION

INSTRUCTIONS

Remove all gauges from the stock bezel and housing, leaving gear indicator in original position. Assemble the board as follows: with the board on the bottom (facing up), followed by a spacer, the black overlay, another spacer and the smoked acrylic top. Carefully, insert a screw into each of the four columns as noted above; two at the top of the panel, two at the bottom. Place the new dash assembly into the stock gauge housing; secure into place with the existing stock screws, spacers, and washers.

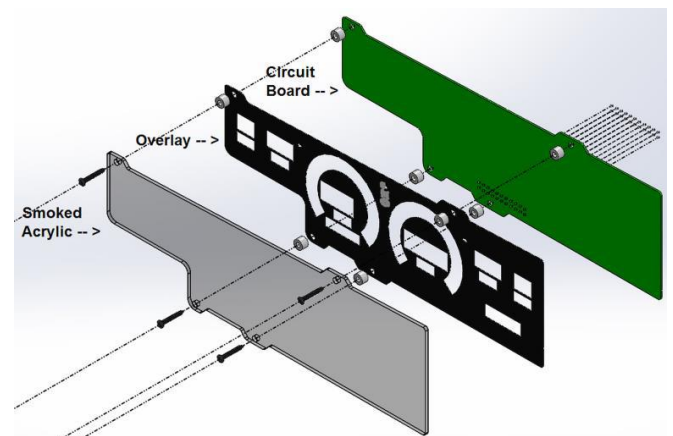

WIRING INSTRUCTIONS

Note: Automotive circuit connectors are the preferred method of connecting wires. However, you may solder if you prefer.

Note: LS Engines or any other Computer based engine systems most use provides sensors and install new wires to new sensors

Note: If doing a LS engine swap, pick up the tach signal wire from the ECM/ECU and then set the tach switch to 4-cylinders. You may also need to order the Intellitronix LS Engine Swap Adapter Kit for Series 1, 2 and 3 engines. The part number is 8014LS. If you are getting the tach signal from the ECU, the resistor in the adapter kit will help pull a stronger signal for the tachometer. If your engine is a LS the Tachometer will need to be put into 4 cylinder mode by removing Resistors if the Tachometer does not have a push button for programing, please call Tech Support at Intellitronix, as you may need to send the gauge back to us to be reconfigured. There is no charge for this additional service.

Ground – Black--This is the main ground for the display system. A wire should be run from this board to the vehicle engine block for the best ground. Use 18 AWG or larger wire to ensure sufficient grounding. Proper vehicle grounding is extremely important for any gauges (or electronics) to operate correctly. The engine block should have heavy ground cables to the battery, frame, and firewall. Failure to properly ground the engine block, senders, or digital dash can cause incorrect or erratic operation.

NOTE: We are updating the Circuit Boards here at Intellitronix to make improvements. Some of the power wires may not be correct in Installation Guides. The most common one on the dashes is with one power wire it will be Key on Power Pink or Red. If your dash has Pink and Red the Pink is Key on power and the Red is going to be constant Power.

If you have just Red and No Pink, then the Red wire is Key on Power.

You can always verify the wires by looking at the Board where the wires are attached. The board is marked by wire position.

Power - Red--Connect the power terminal to accessory +12V power from the fuse panel or vehicle wiring harness. Using a 5-amp fuse or an inline 5-amp fuse holder This terminal should have power when the key is on or in accessory position. Use 18 AWG wire to ensure the system receives a sufficient power feed.

OR

Battery Red--Connect the +12 Volt terminal to constant +12V power from the battery power source. Using a 5-amp fuse or an inline 5-amp fuse holder Use 18 AWG wire to **Battery Red--** Connect the +12 Volt terminal to constant +12V power from the battery. Use 18 AWG wire to ensure the system receives a sufficient power feed.

Power – Pink--Connect the power terminal to accessory +12V power from the fuse panel or vehicle wiring harness. Using a 5-amp fuse or an inline 5-amp fuse holder. This terminal should have power when the key is on or in accessory position. Use 18 AWG wire to ensure the system receives a sufficient power feed.

Water – Blue - This gauge is incompatible with other sending units, so you must replace the existing water temperature sending unit with the included sender. **Do not** use Teflon tape or other sealer on the new sending unit's threads to avoid inaccurate readings. Connect the blue wire to the sending unit. For best results we suggest running a new wire.

Oil Pressure – Orange - Replace the existing oil pressure sending unit with the unit included. **Do not** use Teflon tape or other sealer on the new sending unit's threads. This will avoid inaccurate ground connections as the sending units get their ground from the threads. The oil sender gets its ground from the threading into the engine block, thus proper grounding is crucial. Connect to the sending unit.

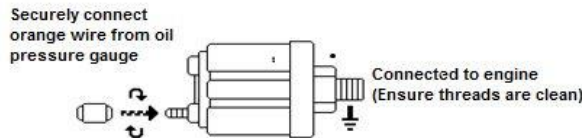

Dimmer – Purple Connect to the parking lights to dim the LEDs 50% when the headlights are on. However, ***DO NOT*** connect to the headlight rheostat control wire, or the dimming feature will not work properly and may cause damage to Unit.

Brake – Tan - Connect to the parking brake wire from the dash to negative side of parking brake light switch. **NOTE:** If you are using a one wire switch you may need to switch to a two-wire switch. This wire is an optional wire some vehicles may not require

High-Beam – Brown - Connect the brown wire on the Dash unit to your high beam headlight circuit. This wire is powered on when the high beam is turned on.

Turn Signals - Grey Two 18-gauge wires, one for each signal. Each wire is labeled on the printed circuit board as 'LEFT' and 'RIGHT'. Connect each wire to its corresponding indicator circuit.

OR

Right Turn Signals - Grey with White strip 18-gauge wire is the - RIGHT turn signal

Left Turn Signals - Grey with Black strip 18-gauge wire is the - Left turn signal. Each wire is also labeled on the printed circuit board as 'LEFT' or 'RIGHT'. Connect each wire to its corresponding indicator circuit.

Voltage Gauge – This Gauge Requires no wire hookup. Volt Gauge is built into the dash panel and is powered by the main power and ground connection of the dash. It does have an Adjuster to fine tune the voltage. Note: you will need to adjust it before fully installing the dash



CABLE BUTTONS

Trip/Cal Button - Grey Cable Button or Push button on Dash - There are two grey wires connected to the push-button for the speedometer board. Mount the switch in a convenient location such as under the steering column so that you may easily reset your trip odometer or other speedometer functions.

Tach program Button – Grey Cable Button or Push button on Dash There are two grey wires connected to the push-button for the tachometer board. Mount the switch in a convenient location such as under the steering column so that you may easily set the other functions of the tachometer.

Check Engine - Green/Yellow Connect to the Negative side of the Check Engine Light circuit. Check Engine light will come on when working with a PCM

Clock Setting Press the setting button under each section for hour and minute settings.

Fuel – Yellow The fuel gauge sending unit is not normally supplied because the display system can use the existing fuel level sending unit in the tank in most cases. If your wiring harness already has a single wire routed through the vehicle for the fuel sender, then it may be used. If using a wire from an external harness, make sure that the wire does not have power. Fuel senders reference their ground from the sender mounting plate. Connect the yellow wire to the factory sending unit. Be sure the toggle settings on the switch match those displayed on the panel, as illustrated. **NOTE: If the switch is on the back of the circuit board the position is UPSIDE DOWN!**

Both switches in the **ON** position for Ford/Chrysler

For GM - #1 toggle is **ON**





2 toggle is **OFF**.

Both switches in the **OFF** position for VDO

For Universal/Stewart Warner

#1 toggle is **OFF**

2 toggle is **ON**.

Fuel Selector Switch Position		
Manufacturer	Switch Position	Ohm Range (Empty to Full)
Ford/ Chrysler		73-10 OHM
GM		0-90 OHM
VDO		10-180 OHM
Universal/ Stewart Warner		240-33 OHM

Note: If doing a LS engine swap, pick up the tach signal wire from the ECM/ECU and then set the tach switch to 4-cylinders. You may also need to order the Intellitronix LS Engine Swap Adapter Kit for Series 1, 2 and 3 engines. The part number is 8014LS. If you are getting the tach signal from the ECU, the resistor in the adapter kit will help pull a stronger signal for the tachometer. If your engine is a LS the Tachometer will need to be put into 4 cylinder mode by removing Resistors if the Tachometer does not have a push button for programing, please call Tech Support at Intellitronix, as you may need to send the gauge back to us to be reconfigured. There is no charge for this additional service.

Tachometer – Green wire

Connect the wire from the tachometer to the negative terminal of the coil or a direct tach output lead from your distributor or electronic control module. If you are using an aftermarket capacitive discharge ignition system, such as an MSD, you must use the designated 'tach output' connection on the electronic box. Do not make any connections directly to the coil with this type of system. With high output Ignition systems may also create frequency noise that may interfere with operation of gauges that may require a tachometer filter.

If your vehicle has a GM HEI ignition, connect to the terminal marked 'TACH', or, on some systems, a single white wire with a spade terminal.

If your vehicle has a magneto system, connect the tach signal wire to the negative side of the coil. Do not connect the tach terminal to the positive (+ or high voltage) side of the ignition coil or may need a Tachometer adapter for proper operation of your Digital Gauges.

Diesel engines will require a Diesel Tachometer adapter for proper operation of your Digital Gauges.

To change settings:

The display will stay in Settings Mode until it receives a signal from the ignition system. To program the unit after starting the engine, shut the engine off and turn on only to the accessory position.

When in accessory mode, the settings menu will scroll through the settings menu. A light tap on the button engages the menu system.

1. Sets # of digits in RPM display, using button, display shows: (hundreds) 8800, (tens) 8880, and (ones) 8888.
2. Sets # of cylinders using button, display shows: 1cy, 2cy, etc.
3. Sets first digit on max RPM on gauge bar display (in thousands) using button, display shows: 1000 to 9990.

SPEEDOMETER (you have three methods for speedometer connection)

1.)Speedometer – White - (Factory sender with Powertrain Control Module) When using a LS engine swap, you will need to pick up the Speedometer signal wire from the PCM Pin 50 on the red connector. (This pin may Differ. Refer to your vehicles Pinout Chart for accuracy). Any other Computer based engine will need to use to use the PCM/ECM to run the speed signal for the Speedometer.(Consults Pinout Chart)

2.)Speedometer – White - (Factory two wire sender no PCM) - Most vehicles built after 1984 have an electronic transmission sender. If your vehicle is already equipped with an electronic transmission, then the electronic vehicle sender will usually have Two wires attached to it. One connects to the Signal wire on dash (we prefer this to be high output). The other wire (Low output) Ground at the Engine block. To find High and Low output wire color or pin location will need to be looked up by Vehicle vin or Model and year or (Consults Pinout Chart).

3.)Speedometer - White (Intellitronix Speed Sender) - Disconnect the mechanical speedometer cable from the transmission and thread the new electronic sensor onto the transmission. This panel comes with a 3-wire sensor. If you are using this sensor, the **white** wire is the speed signal; connect this to the speed signal wire on your gauge. The **red** and **black** wires in the cable are switch power (12VDC) and ground, respectively. **NOTE:**(Twist all Three wires together and this will provide an additional level of interference protection.) The speed signal wire should not be routed alongside the tachometer, ignition, or any other high-current or high-voltage wires

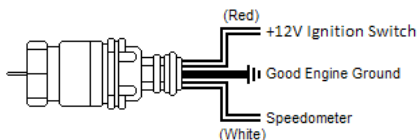

Trip Distance

A single *tap* of the recall button will activate the trip meter in the odometer display. A decimal point will appear which will indicate that you are in trip meter mode. *Holding* the recall button will clear out the trip distance. To return to the default odometer display, *tap* the recall button again. The decimal point will disappear, indicating that you are back in the default odometer display.

Setting the Odometer

While scrolling through 'CAL' mode you will see 'ODO' appear. This will allow you to enter the vehicle's actual mileage. Press the trip button again at this point and you will enter the odometer set up mode. Press quickly to change the number of the digit on the right. Press and hold to advance to the next digit. Do this for all 5 digits. **For Example:** To enter the mileage reading 23456 into the odometer,

at the 'ODO' prompt, tap the small black button (quickly) two times, until the number **2** is displayed. Then press and hold the button until the numbers **20** are displayed. Tap the button 3 times until **23** is displayed. Press and hold the button until **230** is displayed and continue in this manner until **23456** is displayed. The speedometer will advance to the home screen, five seconds after the last number is entered.

Recording and Viewing Performance Data

Follow these steps to record and recall Performance Data (high speed, ¼ mile ET, and 0-60 time):

1. Before each run, your car must be at a complete stop at the starting position. *Press and hold* the pushbutton as it cycles through the performance data. At the end, the odometer will re-set and all performance data will be cleared. This will not affect your stored calibration value or the odometer reading.
2. Press the push-button until 'HI-SP' is displayed. The gauge will automatically cycle through the performance data.
3. Start the run, pass, session, etc., as mentioned above.
4. When finished, repeat *Step 2* to view the data gathered from the run. While stopped, you can view this data as often as you wish. However, once it finishes scrolling one time, the memory is ready to record new data and will begin recording again once the vehicle starts to move. The highest speed measured over multiple runs will be retained in memory.

SPEEDOMETER CALIBRATION PROCEDURE

Your Intellitronix dash panel is equipped with our Digital Performance Speedometer which has factory settings that are ***pre-set with the industry standard setting of 8,000 pulses per mile to match your vehicles factory settings.*** This electronic speedometer displays speed and includes an odometer, trip meter, highspeed recall, 0-60 time, and quarter-mile elapsed time. It can be calibrated with the push-button to adjust the speedometer when you have ***Different sizes, wheel sizes, and gear ratios.***

The single push-button is used by a *quick tap* to toggle between odometer and trip meter. The microprocessor distinguishes between a *quick tap* and a *press and hold* which will reset the trip meter in trip mode or display performance data in odometer mode.

CALIBRATION

The Digital Performance Speedometer leaves the factory with a factory pre-set industry standard setting of 8,000 pulses per mile. You should ***not have to recalibrate your speedometer, unless you have changed the original tire size or the rear end gear ratio.***

Also, if using the Intellitronix GPS Sending Unit, (S9021 – not included) the speedometer does not need to be calibrated.

NOTE: DO NOT attempt to recalibrate your speedometer until after it is working properly, and you have determined that the speed is consistently incorrect. The calibration procedure will NOT correct a faulty installation or improper wiring.

WARNING: If, while in 'CAL' mode, **you do not move the vehicle but press the button again**, the microprocessor will NOT have received any data and the unit will display 'Err' and will revert to the factory settings. At a minimum, drive some distance and return to the start if necessary. If you miss stopping the display at 'CAL', simply repeat the steps.

To calibrate:

1. **Locate a measured mile or KPM where you can safely start and stop your vehicle.** By running the vehicle over this measured distance, the speedometer will learn the number of pulses outputted by the speedometer sensor during a specific measured distance. It will then use this acquired data to calibrate itself for accurate reading. There is a small recall pushbutton in the center of the panel used to calibrate and read all the data stored in the speedometer. After installing your speedometer according to the wiring instructions, when the ignition is on it should immediately display the default screen of **0 MPH**, if the vehicle is not moving.

NOTE: You will then need to drive your vehicle to the predetermined measured mile. During this trip, the speedometer should read something other than 0 MPH. If it does not change, return and locate the problem before continuing. Otherwise, proceed with the calibration.

2. Stop at the beginning of the measured mile with your vehicle running and in odometer mode (NOT trip mode), press and hold the push-button until the odometer displays 'HI- SP'. On its own, the gauge will then cycle through the recorded performance in the following order: '0 - 60', '1/4', 'ODO', and 'CAL'.
3. While 'CAL' is displayed, quickly *tap* the push-button once. This will put the speedometer in Program Mode. If you did not tap while 'CAL' is displayed, the pulses per mile will be displayed on the odometer and the display will go back to MPH mode. Otherwise, you will now see 'CAL' displayed along with the number '0'. This indicates that the microprocessor is now ready for calibration.
4. When you are ready, begin driving on the metered mile. You will notice that the reading will start counting. The odometer will begin to display the incoming pulse count. Drive the vehicle through the measured mile (speed is not important, only the distance traveled).
5. At the end of the mile, stop and press the push-button again. The odometer will now display the new number of speedometer pulses that were registered over the distance. The odometer will continue to display the pulse reading for a few seconds. Once it reverts to the default mode, you have successfully calibrated your speedometer.

Made in America

Lifetime Guarantee



Technical Support

Monday – Friday

9am to 5 pm EST

(440) 359 7200

support@intellitronix.com

CHECK OUT THE **SUPPORT** PAGE AT

www.intellitronix.com

FOR QUICK ANSWERS (**Q&A**) TO YOUR QUESTIONS



This product carries a limited Lifetime Warranty.

This warranty is limited to replacement or repair of the unit at the discretion of Intellitronix.

RETURN POLICY PROCEDURES

Return Policy Instructions

1. Download the Intellitronix Return/Repair Form and fill in the information on the form about the product.
2. Place the product being returned in the original packaging that it came in and include a copy of the completed Intellitronix Return/Repair Form.
3. All packages must be accompanied with an RMA Number.

Please call Technical Support at +1 440-359-7200 to receive an RMA Number.

4. Mail the product being returned with the completed Return/Repair Form and a copy of the original sales invoice.

Request for Product Refund

1. All returns for a refund must have a completed Intellitronix Return/Repair Form included in the package with the returned product.
2. If the return is for a product that is not defective a 20% restocking fee will be charged. The product must be in the same pristine condition that it was sent to you.
3. Proof of purchase is required. Please include a copy of the original sales order with the returned product.
4. All product must be returned undamaged and in working order in the original packaging including plexiglass, sending units, mounting hardware, or you will be subject to additional charges for product and accessories not returned.
5. All refunds will be reviewed by the Accounting Office.