

# INSTALLATION INSTRUCTIONS

## 3 3/8" & 5" ELECTRIC QUAD GAUGES

2650-1178



### QUESTIONS:

If after completely reading these instructions you have questions regarding the operation or installation of your instrument(s), please contact Auto Meter Technical Service at **815-899-0801**. You may also email us at **service@autometer.com**. Additional information can also be found at <http://www.autometer.com>

### Mounting

Mount a 3 3/8" gauge in a 3 3/8" dia. hole and a 5" gauge in a 4 5/8" dia. hole in the dashboard. Fasten with brackets supplied as shown. **(Electrical wire for installation not included.)** To assure proper functioning of this instrument, please read instructions thoroughly before installing.

**NOTE:** Some late model vehicles use electronic sensors in their pressure and temperature senders for engine control functions. Before removing the original sender, we recommend that you contact your automotive dealer to be sure no critical functions will be disrupted. With pressure gauges it is beneficial to add a T-fitting to install your new gauge and to keep the warning light operational. This allows you to monitor the pressure and still have a warning light to indicate emergency conditions. The ground, fuel sender, temperature sender, and oil sender wires should be routed through fire wall using the supplied grommet.

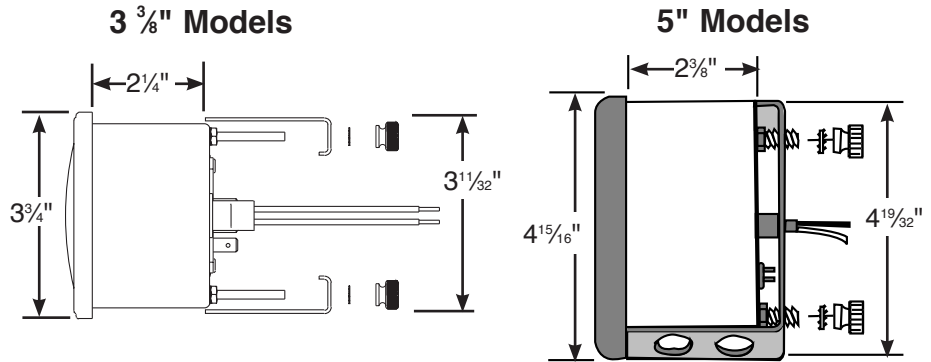

### Step 1

1. Disconnect negative (-) battery cable.

#### CAUTION:

**Do not touch ignition wire to the sender terminal on back of gauge or the sender will be damaged.**

### Step 2

#### Fuel Level

1. Gauge connects to 240-33 ohm fuel sender (3262), supplied in Quad gauge/Speedometer kit. Sender is **not included** in individual Quad gauges. The 3262 or comparable 240-33 ohm sender will be required. Route proper length of 18 gauge wire from fuel tank to gauge. Connect one end to terminal post on fuel level sender and the opposite end to the spade terminal labeled "FUEL" on back of gauge. See illustration.

#### 3 3/8" Models

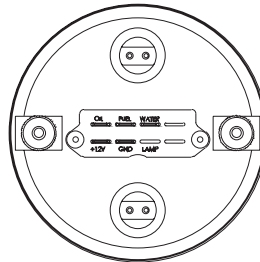

#### 5" Models

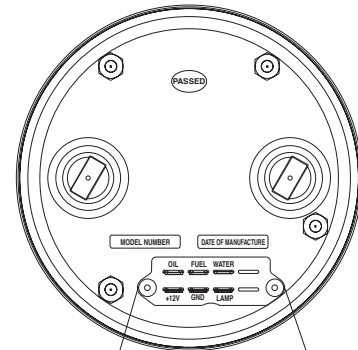

Connect to terminal post on fuel tank sender.

Grommet

#### CAUTION!

As a safety precaution the Red wire of this product should be fused before connecting it to the positive (+) side of the 12V DC battery. We recommend using a 4 Amp, 3AG fast-acting type cartridge fuse (Littlefuse® # 312 004 or an equivalent) inline with the Red wire of our product.

### Step 3

#### Voltmeter

1. Using 18 gauge wire, route wire through firewall using grommet. Attach one end to the negative GND (-) spade terminal on back of gauge, and the opposite end to a good engine ground. See illustration at right.
2. Attach one length of wire to the positive +12V spade terminal on back of gauge and opposite end to +12V terminal on ignition switch or other switched +12V power source.

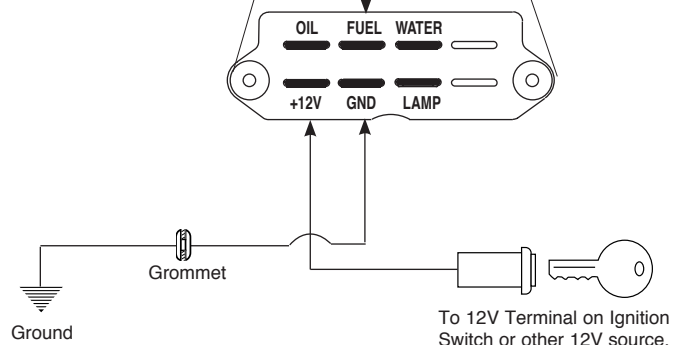

#### CAUTION:

**Do not touch ignition wire to the sender terminal on back of gauge or the sender will be damaged.**

## Step 4 Water Temperature

1. Install water temperature sender. Remove stock sender for water temperature indicator light and install new sender. Sender should automatically be grounded when installed. If not, proper ground connections should be made.
2. Route 18 gauge wire through firewall using grommet. Connect one end to the terminal post on sender and opposite end to spade terminal labeled "WATER" on back of gauge. See illustration below.

### 3 3/8" Models

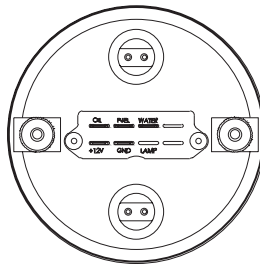

TEMPERATURE SENDER

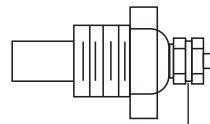

**CAUTION!**  
As a safety precaution the Red wire of this product should be fused before connecting it to the positive (+) side of the 12V DC battery. We recommend using a 4 Amp, 3AG fast-acting type cartridge fuse (Littlefuse® # 312 004 or an equivalent) inline with the Red wire of our product.

### 5" Models

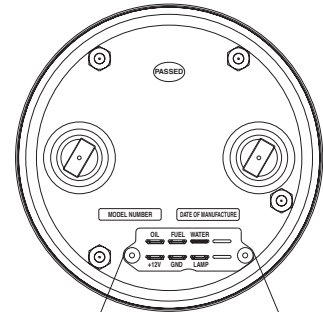

Grommet

Grommet

**CAUTION:**  
*Do not touch ignition wire to the sender terminal on back of gauge or the sender will be damaged.*

## Step 5 Oil Pressure

No. 2242 for Domestic Cars with 1/8" NPT Outlet. Ford uses 1/4" NPT Adapter included.

1. Remove stock sender for dash warning light and install gauge adapter. Sender fits 1/8" NPT and comes with 1/4" NPT adapter. Sender should automatically be grounded when installed. If not, proper ground connections should be made.
2. Route 18 gauge wire through firewall using grommet. Connect one end to terminal post on pressure sender, and opposite end to the spade terminal labeled "OIL" on back of gauge. See illustration above.

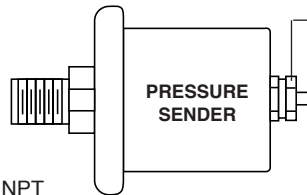

PRESSURE SENDER

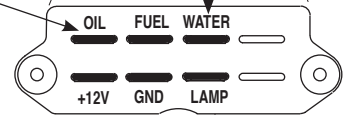

**CAUTION:**  
*Do not touch ignition wire to the sender terminal on back of gauge or the sender will be damaged.*

## Step 6 Lighting (3 3/8" models only)

1. Connect white wire to dash lighting or to other +12V power supply. Connect black wires to negative ground source.

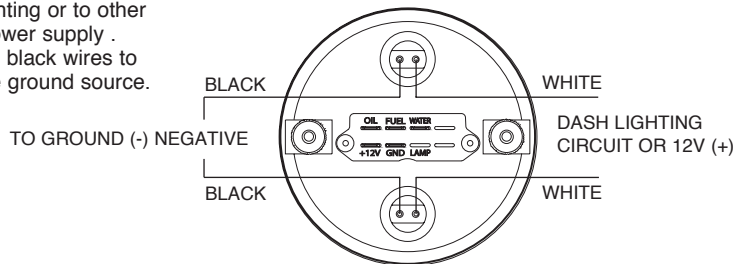

## Lighting (5" models only)

1. Connect one wire to dash lighting circuit or to other 12V power source and opposite end to spade terminal labeled "LAMP" on back of gauge.

Dash lighting or +12V power supply  
5" models only

## Step 7

1. Reconnect negative (-) battery cable.

### SERVICE

For service send your product to Auto Meter in a well packed shipping carton. Please include a note explaining what the problem is along with your phone number. Please specify when you need the product back. If you need it back immediately mark the outside of the box "RUSH REPAIR," and Auto Meter will service product within two days after receiving it. (\$10.00 charge will be added to the cost of "RUSH REPAIR.") If you are sending product back for Warranty adjustment, you must include a copy (or original) of your sales receipt from the place of purchase.

### 12 MONTH LIMITED WARRANTY

The manufacturer warrants to the consumer that this product will be free from defects in materials and workmanship for a period of twelve (12) months from the date of the original purchase. Products that fail within this 12 month warranty period will be repaired or replaced at the manufacturer's option to the consumer, when determined by the manufacturer that the product failed because of defects in material or workmanship. This warranty is limited to the repair or replacement of parts in the instrument and the necessary labor done by the manufacturer to affect the repair or replacement of the instrument. In no event shall this warranty exceed the original purchase price of the instrument, nor shall the manufacturer be responsible for special, incidental or consequential damages or costs incurred due to failure of this product. Warranty claims to the manufacturer must be transportation prepaid and accompanied with dated proof of purchase. This warranty applies only to the original purchaser of product and is non-transferable. All implied warranties shall be limited in duration to the said 12 month warranty period. Breaking the instrument seal, improper use or installation, accident, water damage, abuse, unauthorized repairs or alterations voids this warranty. The manufacturer disclaims any liability for consequential damages due to breach of any written or implied warranty on all products made by the manufacturer.

FOR SERVICE CONTACT: AUTO METER PRODUCTS Inc. 413 W. Elm St., Sycamore, IL 60178 USA (815)899-0801 or

Email us at [service@autometer.com](mailto:service@autometer.com)